

Proposed Approach for Driving EO Phase Modulators

- Electro-optic (EO) phase modulators, such as the fiber-coupled version in Figure 1, are frequently driven at rates of 1 GHz or higher.
- A limited selection of voltage sources, some of which are highly specialized, can drive EO phase modulators at these high frequencies.
- During this work, we investigated the option of driving an EO phase modulator using a basic setup of a function generator paired with an amplifier. Within this presentation we:
 - Summarize our process for estimating the power needed to drive the EO phase modulator and illustrate how we used this estimated power to choose a function generator and amplifier.
 - Describe the design and implementation of the experimental setup.
- The ability of our chosen voltage source to drive the EO phase modulator was determined by examining the modulated optical spectra of the light wave.
 - We used a Fabry-Perot scanning interferometer to measure the spectra. (It was chosen for its ability to resolve fine spectral features: at a wavelength of 1550 nm, a 1 GHz frequency step corresponds to a wavelength step of approximately 0.8 pm.)
 - The relationship between the optical spectrum of the light and the modulation depth was shown to agree with theoretical predictions.



Figure 1: The LN53S-FC Fiber-Coupled EO Phase Modulator

Relationship of Phase Modulation and Driving Voltage

- **Modulating the driving voltage, $V(t)$, adds a varying phase offset to the light wave.**
 - The phase, ϕ , of the light wave is directly proportional to the optical path length traveled by the light, which is controlled by $V(t)$.
 - The optical path length is the product of the refractive index times the physical length of the path through the medium.
 - Modulating the driving voltage, $V(t)$, which is applied across the lithium niobate (LiNbO_3) crystal contained in the EO phase modulator as conceptually diagrammed in Figure 2, varies the refractive index of the crystal.

- **There is a linear relationship between the driving voltage and the resulting phase offset.**

- A light wave with an amplitude, E_o , a frequency, f_o , and an accumulated phase shift, $\phi(t)$, can be mathematically expressed as:

$$E_o \sin(2\pi f_o t + \phi(t)).$$

- The applied driving voltage, $V(t)$, is often expressed in terms of the half-wave driving voltage, V_π . Driving an EO phase modulator at its half-wave voltage generates a phase shift equal to pi: $\phi(t) = \pi$.
- Achieving full modulation depth requires driving the phase modulator from $-V_\pi$ to $+V_\pi$, as shown in Figure 3.
- The amplitude of the peak-to-peak radio frequency (RF) driving voltage, V_{pp} , required to achieve full 2π modulation (full modulation depth) is $2V_\pi$.

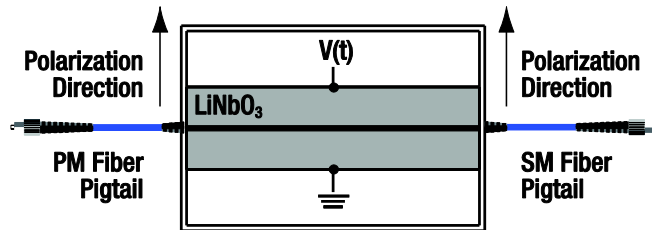

Figure 2: Polarization maintaining (PM) fiber couples linearly polarized light into the EO phase modulator. The light is polarized parallel to the direction of the applied driving voltage, $V(t)$, which modulates the refractive index of the LiNbO_3 crystal. A modulated phase shift is added to the light without affecting its polarization. The light from the output of the modulator is coupled into a single mode (SM) output fiber.

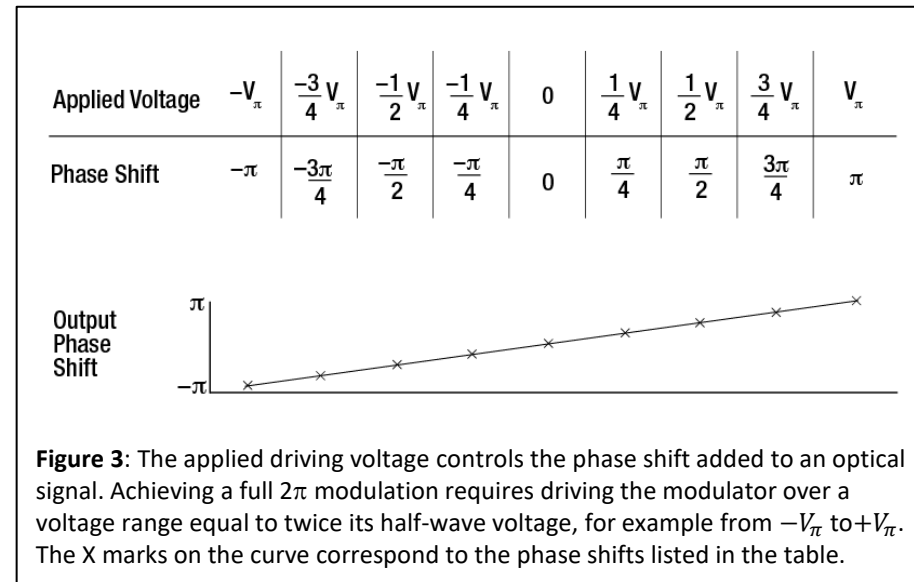

Figure 3: The applied driving voltage controls the phase shift added to an optical signal. Achieving a full 2π modulation requires driving the modulator over a voltage range equal to twice its half-wave voltage, for example from $-V_\pi$ to $+V_\pi$. The X marks on the curve correspond to the phase shifts listed in the table.

Modulation Depth and Frequency Sidebands

- Phase modulation, like all other signal modulation, generates sidebands in the frequency spectrum.

- The spectrum of unmodulated narrowband laser light consists of a single peak at the laser carrier frequency f_o .
- Modulation transfers energy from the laser carrier to sidebands.

- The modulation depth is an expression of the extinction ratio of the phase offset function.

- When the time-varying phase offset is $\phi(t)$, the modulation depth is $\left| \frac{\phi(t)_{max} - \phi(t)_{min}}{2\pi} \right|$.
- Full modulation depth occurs when the modulation depth = 1.

- It is often convenient to sinusoidally vary the phase offset.

- The modulated optical signal, with modulation frequency f_m is then $E_o \sin(2\pi f_o t + \phi(t)) = E_o \sin(2\pi f_o t + \phi_o \sin(2\pi f_m t))$.

- The modulation depth is $\left| \frac{\phi_o}{\pi} \right|$. With a peak-to-peak modulation voltage, V_{pp} , $\frac{\phi_o}{\pi} = \frac{V_{pp}}{2V_\pi}$.

- The laser light in Figure 4 has been sinusoidally phase modulated. The carrier frequency is f_o and the symmetric sidebands occur at frequencies $f_o \pm Nf_m$ (where $N = 1, 2, 3, \dots$).

- As is discussed in the following slides, sinusoidally varying the phase offset simplifies the mathematical expression for the optical signal's spectrum. This makes it straight-forward to estimate the powers in the carrier and sidebands peaks for a given V_{pp} .

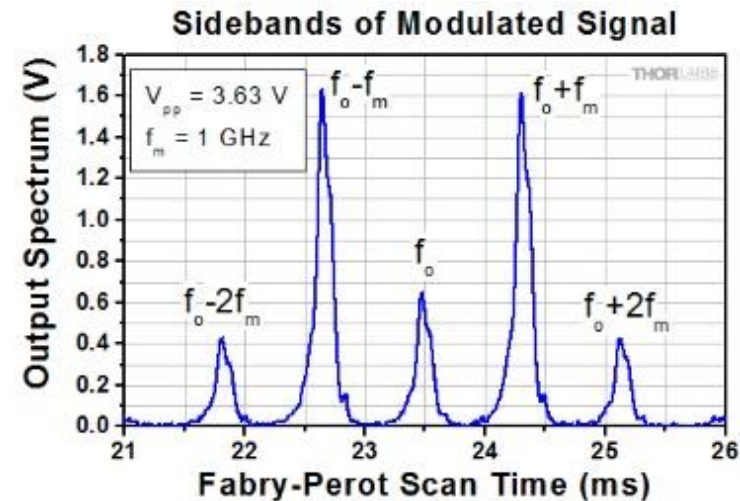

Figure 4: Spectrum of a 1550 nm laser modulated at 1 GHz with a modulation depth of approximately 0.56. The trace was obtained using a scanning Fabry-Perot interferometer, and the x-axis references the interferometer's scanning time. Details of the relationship between the scanning time and the frequency content of the signal are discussed on Slide 9.

Modulation Depth and the Power Spectrum

- When the phase of the light is sinusoidally modulated, the optical signal can be mathematically expressed as a sum of sinusoidal functions, each multiplied by a constant. [1], [2] This mathematical form is convenient for a few reasons:

- It simplifies the work needed to find the power distribution in the signal as a function of frequency.
- The effect of the modulation depth, $\left|\frac{\phi_o}{\pi}\right|$, on the power in the carrier and sidebands becomes more clear.

- The more convenient expression for the phase modulated optical signal can be derived from the previous form,

$$E_m(t) = E_o \cos(2\pi f_o t + \phi_o \sin(2\pi f_m t)),$$

which is equivalently: $E_m(t) = \text{Re}\{E_o \exp(i2\pi f_o t) \exp(i\phi_o \sin 2\pi f_m t)\}$.

- Because $\exp(i\phi_o \sin 2\pi f_m t)$ is periodic with period $1/f_o$, it can be expressed as a Fourier series,

$$\exp(i\phi_o \sin 2\pi f_m t) = \sum_{n=-\infty}^{\infty} C_x(nf_m) \exp(i2\pi n f_m t),$$

$$\text{in which } C_x(nf_m) = \frac{2\pi f_m}{2\pi} \int_{-\frac{\pi}{2\pi f_m}}^{\frac{\pi}{2\pi f_m}} \exp(i\phi_o \sin 2\pi f_m t) \exp(-i2\pi n f_m t) dt.$$

- When the substitution $\theta = 2\pi n f_m t$ is performed, the $C_x(nf_m)$ are revealed to be Bessel functions of the first kind, $J_n(\phi_o)$,

$$C_x(nf_m) = \frac{1}{2\pi} \int_{-\pi}^{\pi} \exp[i(\phi_o \sin \theta - n\theta)] d\theta = J_n(\phi_o).$$

[1] Reference Data for Radio Engineers (6th ed., pp. 23-1-23-26). Indianapolis, IN: Howard W. Sams & Co., Inc.

[2] "Spectrum Analysis Amplitude and Frequency Modulation." Keysight Technologies, 31 July 2014. Web. 1 Oct. 2015.

Modulation Depth and the Power Spectrum

- Using the equations on the previous slide, the phase modulated optical signal can be expressed in a convenient form:

$$E_m(t) = E_o \sum_{n=-\infty}^{\infty} J_n(\phi_o) \cos[(2\pi f_o + n2\pi f_m)t].$$

- The $J_n(\phi_o)$ are constants: each is the value of the Bessel function evaluated at a single ϕ_o .
 - The time-varying signal consists of a sum of sinusoids, each multiplied by a constant.
- The spectrum of the optical signal is the Fourier transform of $E_m(t)$: a sum of Dirac delta functions, whose amplitudes are the values of the corresponding $J_n(\phi_o)$.
- Plotted in Figure 5 are the squared values of the Bessel functions, $J_n(\phi_o)$ for $n = 0, 1, 2,$ and $3,$ which correspond to the power in the carrier and first three sidebands, respectively, of the modulated optical signal.

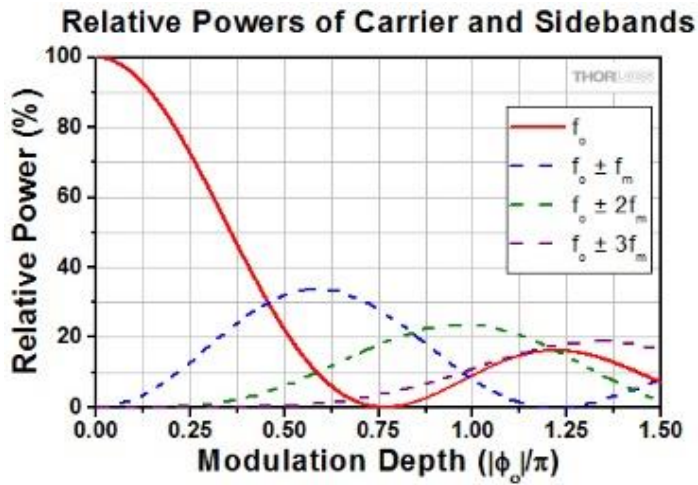

Figure 5: Curves describing the powers in the carrier and first three sidebands, for specific modulation depths, when the optical signal is sinusoidally phase modulated. These curves are the squared values of Bessel functions of the first kind: $[j_n(\phi_o)]^2$ with $n = 0, 1, 2,$ and 3 .

- The modulation depth is a function of the peak-to-peak applied driving voltage: $\frac{\phi_o}{\pi} = \frac{V_{pp}}{2V_{\pi}}$.
- The spectral power distribution of the modulated light wave (the relative powers in the central carrier peak and sidebands) can be tailored by controlling the peak-to-peak applied driving voltage, V_{pp} .
- Example: if an application requires the carrier to be suppressed while the powers in the first and second order sidebands are similar, a V_{pp} that results in a modulation depth of 0.75 could be suitable.

Determining the Driving Requirements

- This work investigated the feasibility of using a function generator and amplifier to drive an EO phase modulator. As evaluating this approach required driving the modulator to several different modulation depths, we chose a maximum peak-to-peak driving voltage, V_{pp} , that would achieve the full modulation depth ($V_{pp} = 2V_{\pi}$).
- Half-wave voltages, V_{π} , of fiber-coupled EO modulators are listed on the modulator's individual data sheet and are usually between 2 and 4 V. Driving voltages for free space EO modulators are typically significantly higher.
- Many RF sources specify performance in power (dBm) instead of voltage, while amplifiers typically specify amplification in dB. Because of this, evaluating driver and amplifier options frequently requires calculating the power, in dBm, required to drive the modulator. The following steps outline this process.

1) Identify the peak-to-peak driving voltage, V_{pp} , required to drive the modulator. V_{pp} is application dependent. If the required V_{pp} is not known, we suggest using $V_{pp} = 2V_{\pi}$, which will achieve full modulation depth.

2) Calculate RMS voltage with units of volts. The equation that applies when the driving voltage signal is a sinusoid is:

$$V_{rms} = V_{pp} / (2\sqrt{2})$$

3) Calculate the power in mW to drive the modulator. The modulator's data sheet gives its impedance, Z , in ohms.

$$P_{mW} = \frac{1000 \text{ mW}}{1 \text{ W}} \frac{(V_{rms})^2}{Z}$$

4) Convert power to dBm (from mW).

$$P_{dBm} = 10 \log_{10} \left(\frac{P_{mW}}{1 \text{ mW}} \right)$$

5) Determine amplifier requirements. If the power required by the modulator is greater than that supplied by the RF source, an amplifier can be used to make up the difference.

$$Amp_{dB} \geq P_{dBm} (Required) - P_{dBm} (RF \text{ Source})$$

Example: A typical half-wave voltage is $V_{\pi} = 3.5$ V. Commonly, the modulator's impedance is close to the RF source impedance, which is typically 50 Ω . Using these values, we calculate a required power of 20.9 dBm to achieve full modulation depth. If the RF source supplies 16 dBm, the amplifier must provide an amplification of at least 4.9 dB.

Experimental Design: Component Overview

This setup allowed us to drive the EO phase modulator using our proposed RF voltage source and to determine whether this RF voltage source was driving the modulator as expected.

- An amplified (Mini-Circuits, ZX60-P103LN+) 1 GHz voltage signal from a function generator (Vaunix, LMS-322D) drove the EO phase modulator. A low-pass RF filter (Mini-Circuits, BLP-1200+) attenuated RF signal harmonics.
- A mating sleeve coupled a 1550 nm single frequency fiber-coupled laser ([SFL1550P](#)) with the fiber-coupled EO phase modulator ([LN53S-FC](#)). A triplet fiber collimator ([TC18FC-1550](#)) collimated the output of the modulator.
- An achromatic lens ([AC254-125-C](#)) focused the free-space collimated output at the center of the cavity of the 10 GHz Fabry-Perot scanning interferometer ([SA210-12B](#)), as focusing the light improves the [finesse](#) of the Fabry-Perot cavity.
- A Fabry-Perot Control box ([SA201](#)) scanned the cavity length, and therefore the resonant frequency of the Fabry-Perot interferometer. The control box also amplified the photodiode signal for input to an oscilloscope.
- The spectrum of the modulated signal was measured by scanning the length of the Fabry-Perot interferometer and recording the resulting spectrum on the oscilloscope. These measured spectra were used to determine whether the RF voltage source was successfully driving the EO phase modulator.

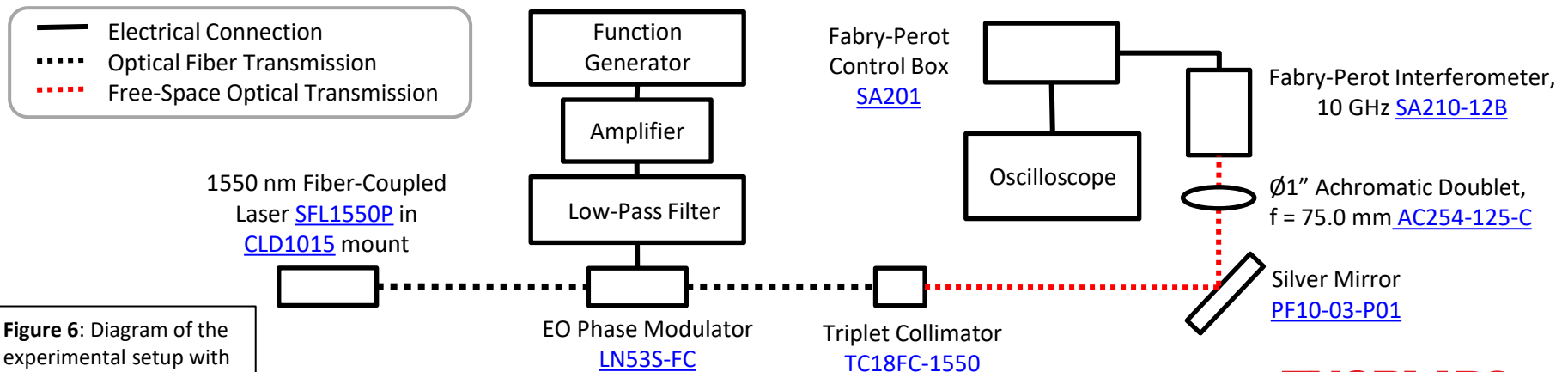

Figure 6: Diagram of the experimental setup with clickable links.

Experimental Setup

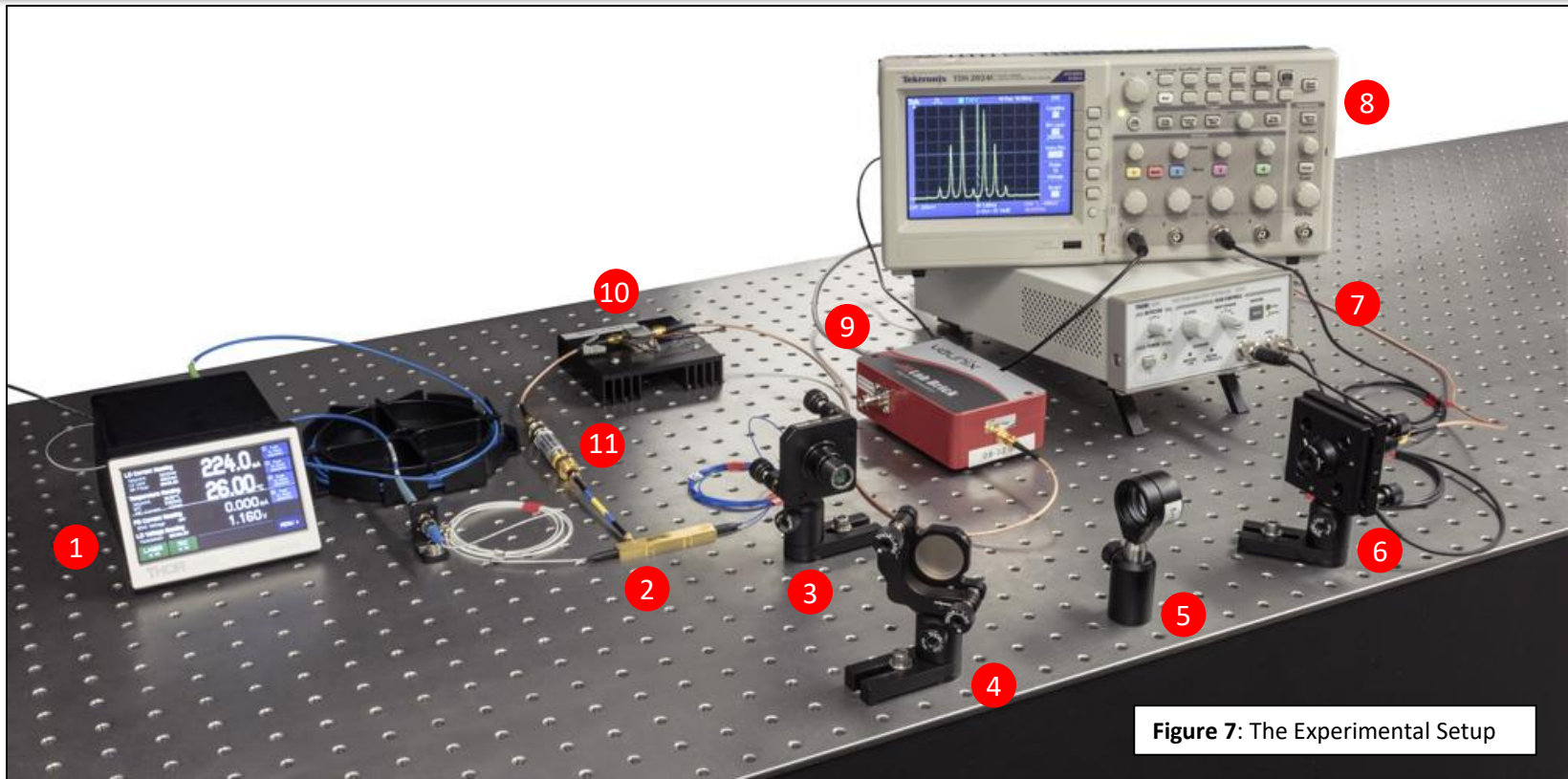
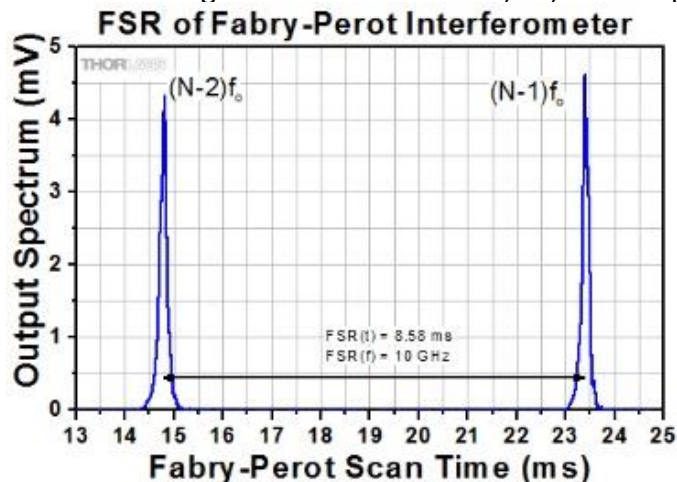

Figure 7: The Experimental Setup

- 1) 1550 nm Fiber-Coupled Laser Source: [SFL1550P](#)
Mount for the Butterfly Package: [CLD1015](#)
- 2) LiNbO₃ Electro-Optical Modulator: [LN53S-FC](#)
- 3) Triplet Collimator: [TC18FC-1550](#)
- 4) Ø1" Protected Silver Mirror: [PF10-03-P01](#)
- 5) Ø1" Achromatic Doublet, f = 75.0 mm: [AC254-125-C](#)
- 6) Fabry-Perot Interferometer, 10 GHz: [SA210-12B](#)
- 7) Fabry-Perot Control Box: [SA201](#)
- 8) Oscilloscope
- 9) Function Generator
- 10) Amplifier for RF Electrical Signal
- 11) Low Pass Electrical Signal Filter

Measurements from the Scanned Fabry-Perot Cavity

- We monitored the optical spectrum of the modulated laser signal to determine whether the RF voltage source used in this work was adequate to drive the EO phase modulator.
- A scanning Fabry-Perot interferometer was used to acquire the spectra.
 - Unlike many spectrometers, it possesses the necessary resolution.
 - The frequencies transmitted by the interferometer correspond to the resonant frequencies of the Fabry-Perot cavity.
 - The resonance condition of the cavity can be tuned by adjusting the separation of the mirrors that define the cavity length.
 - During our analysis, the cavity length was scanned as a linear function of time.
- The scan time interval directly corresponds to the frequency spacing. We found this relationship by:
 - Acquiring a scan of the unmodulated laser signal (no sidebands), shown in Figure 8. The transmitted intensity peaks occur at each resonance frequency of the cavity, and the separation between resonance peaks is the cavity's free spectral range (FSR).
 - Referencing the data sheet for the Fabry-Perot interferometer's specified free spectral range: $FSR(f) = 10 \text{ GHz}$.
 - Measuring the scan time between the transmission peaks: $FSR(t) = 8.58 \text{ ms}$.
 - Converting the scan time interval, Δt , into frequency spacing, Δf , using the relationship: $\frac{\Delta t}{FSR(t)} = \frac{\Delta f}{FSR(f)}$.



- For this experimental setup, the relationship becomes : $\Delta f = \frac{FSR(f)}{FSR(t)} \Delta t = \frac{10 \text{ GHz}}{8.58 \text{ ms}} \Delta t = \left(1.17 \frac{\text{GHz}}{\text{ms}} \right) \Delta t$.

Figure 8: The trace used to measure $FSR(t) = 8.58 \text{ ms}$ is shown to the left. This signal does not include RF modulation. The two peaks correspond to adjacent resonant conditions of the Fabry-Perot interferometer, which is specified to have a $FSR(f)$ of 10 GHz. Relating $FSR(t)$ and $FSR(f)$ makes it possible to convert between scan times and signal frequencies.

Check: Estimate V_π Using the Modulated Spectrum

- We confirmed the ability of the voltage source to drive the EO phase modulator by using optical spectrum measurements to estimate various modulator parameters. Our calculations were consistent with expected values.
 - Modulation frequency, f_m :** Figure 9 shows the carrier (f_o) and $\pm 1^{\text{st}}$ order sidebands ($f_o \pm f_m$) were separated by a $\Delta t = 0.86$ ms time interval and a $\Delta f = f_m$ frequency spacing. Using $\Delta f = (1.17 \text{ GHz/ms}) \Delta t$, $f_m = 1 \text{ GHz}$.
 - Modulation depth (ϕ_o/π):** The carrier and $\pm 1^{\text{st}}$ order sidebands have nearly the same power, while powers in $\pm 2^{\text{nd}}$ order sidebands are lower by a factor of approximately 0.13. From Figure 10, the corresponding modulation depth is around 0.44.
 - Half-wave voltage (V_π):** Using the relationship $\phi_o = \pi \frac{V_{pp}}{2V_\pi}$, the value of $V_{pp} = 2.85 \text{ V}$, and $\phi_o = 0.44\pi$, the estimated half wave voltage is: $V_\pi = \frac{2.85}{2} \frac{1}{0.44} = 3.24 \text{ V}$.

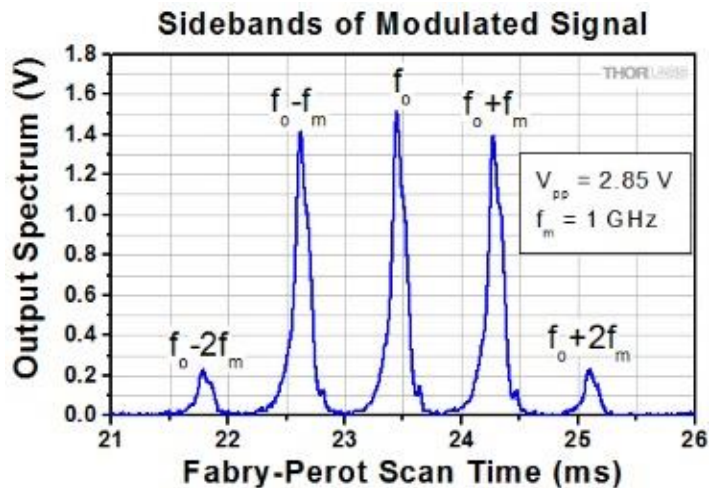

Figure 9: The signal spectrum produced when the 1550 nm laser signal was RF modulated at 1 GHz. The voltage signal used to drive the modulator had a $V_{pp} = 2.85 \text{ V}$.

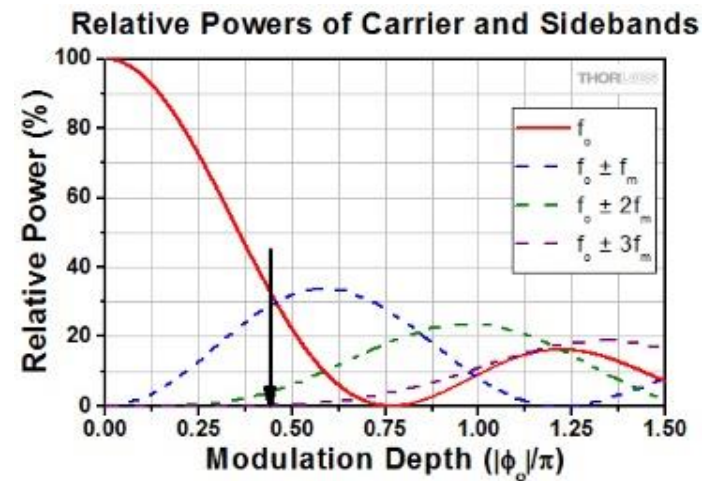

Figure 10: Curves originally plotted in Figure 5. The powers of the carrier and first three sidebands for a range of modulation depths. The arrow indicates the condition corresponding to the signal shown in Figure 9.

Check: Estimate Modulation Depth from a Signal Spectrum

- In another test, we varied the peak-to-peak driving voltage, V_{pp} , and determined whether the modulation depth (ϕ_o/π) matched the expected value. Calculations resulted in the expected value.
 - Previously determined V_{pp} and ϕ_o values:** For a $V_{pp} = 2.85$ V, a modulation depth of 0.44 was estimated from the previously acquired spectral data. With a modulation depth of 0.44, $\phi_o = 0.44\pi$.
 - The ratio approach :** Based on $\phi_o = \pi \frac{V_{pp}}{2V_\pi}$, the ratio $\frac{V_{pp}^a}{\phi_o^a} = \frac{V_{pp}^b}{\phi_o^b}$, which gives $\phi_o^b = \phi_o^a \frac{V_{pp}^b}{V_{pp}^a}$, relates the newly (b) and previously (a) acquired data values.
 - Find the new ϕ_o^b :** The trace in Figure 11 was acquired with $V_{pp}^b = 3.63$ V. Then, $\phi_o^b = \frac{3.63}{2.85} 0.44\pi = 0.56\pi$. For this ϕ_o , the signal spectrum is consistent with the spectral peak powers given by Figure 12: the $\pm 1^{\text{st}}$ order sidebands contain most of the power, and the carrier and $\pm 2^{\text{nd}}$ order sidebands are close in power.

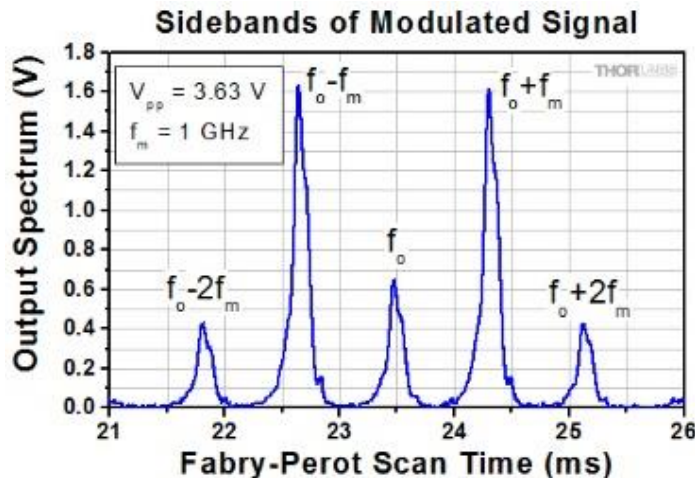

Figure 11: The signal spectrum produced when the 1550 nm laser signal was RF modulated at 1 GHz. The voltage signal used to drive the modulator had a $V_{pp} = 3.63$ V.

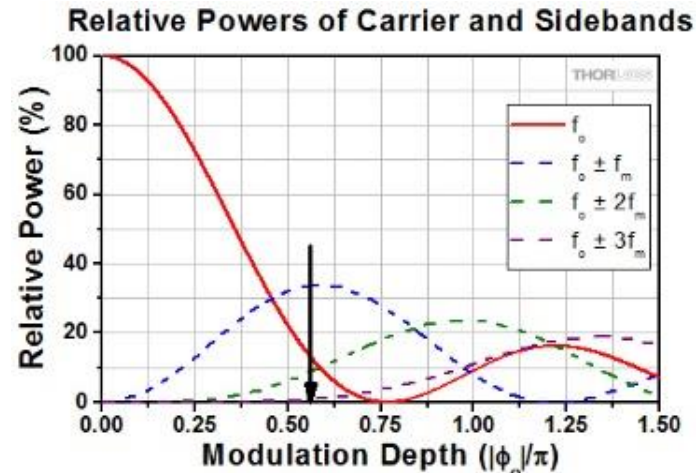

Figure 12: Curves originally plotted in Figure 5. The powers of the carrier and first three sidebands for a range of modulation depths. The arrow indicates the condition corresponding to the signal shown in Figure 11.

Side Note: Including a Low-Pass Filter

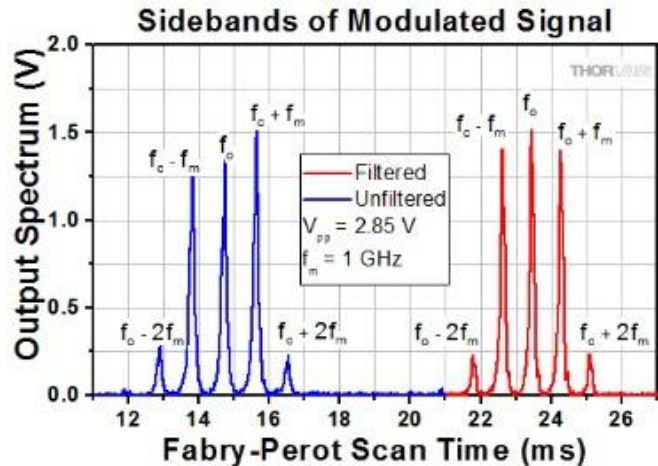

Figure 13: Spectra recorded for $V_{pp} = 2.85$ V without (blue trace) and with (red trace) a low-pass filter in place. Without the filter the signal is not symmetric around the carrier frequency.

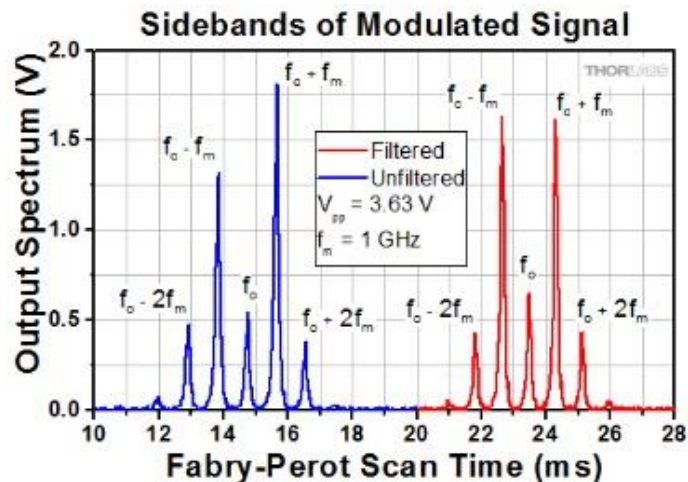

Figure 14: Spectra recorded for $V_{pp} = 3.63$ V without (blue trace) and with (red trace) a low-pass filter in place. Without the filter the signal is not symmetric around the carrier frequency.

It may be necessary to place a low-pass filter between the voltage source and the EO phase modulator.

- The setup did not initially include an electrical low-pass filter.
- Without the low-pass filter, traces of the spectra showed sidebands of the same order did not possess equal power.
- Placing a low-pass filter with a passband limit occurring slightly above the drive frequency (1.2 GHz low pass filter used when driving modulators at 1 GHz) equalized the powers in same-order sidebands (red traces).
- It appears that harmonics on the driving signal resulted in the distortion of the modulated signal. Adding an RF filter remedied the problem, but the cause of the signal distortion was not rigorously investigated.
- This work did not investigate whether using an RF source with better harmonic suppression or lower harmonic distortion would have prevented the signal distortion.
- The characteristics of the driver needed to minimize signal distortion are expected to vary for different EO phase modulators.

Limitations of the Experiment

- The frequency content of the modulated signals was not measured directly. It was necessary to calculate frequency offsets from the recorded scan times of the Fabry-Perot interferometer. This requires using the value free spectral range of the Fabry-Perot interferometer, and it was assumed the values given on its data sheet was accurate.
- The source of the signal distortion, remedied by the low-pass filter, was not rigorously investigated.
- The insertion loss of the low-pass filter was assumed to be negligible.
- The spectral dependence of the low-pass filter was not considered. As the data presented here were taken using the same modulation frequency, the spectral response of the filter was assumed to affect all data sets similarly. However, the frequency dependence of the low-pass filter may have greater implications for applications in which it is necessary to vary modulation frequency.
- Because the applied voltage signals driving the modulator were too fast to measure on the oscilloscope, they were not measured while the data were acquired. Instead, voltages required to drive the EO phase modulator were separately determined using Thorlabs' [MX10A](#) modulator driver. As these measurements were conducted at different times and with different equipment, there may be discrepancies between the voltages measured by the MX10A and the voltages that drove the modulator when experimental data were taken.
- Values of modulation depths were roughly estimated using the data plot of the modeled curves.

Conclusions

- An RF source consisting of a function generator paired with an electrical amplifier was used to modulate an EO phase modulator up to 1 GHz.
- Details of the experimental design and setup were given, including the process used to calculate the power the RF source must supply to drive the EO phase modulator to the desired modulation depth.
- The sidebands generated in the spectrum of the optical signal, as a result of sinusoidal phase modulation, are spaced at integer multiples of the modulation frequency.
- Some advantages of inducing a sinusoidal phase modulation were presented, including being able to use Bessel functions to quickly predict the frequency spectrum of the modulated optical signal given the modulation depth.
- This work used a fiber-coupled EO phase modulator, but the considerations and experimental approach presented here are also applicable to free-space EO phase modulators.
- A low-pass electrical filter placed between the RF driving voltage source and the EO modulator can be used to suppress unwanted distortion of the voltage signal. In this work, a low-pass filter was effective in suppressing the harmonics suspected of causing asymmetries in the spectra of the modulated optical signal.